



A

ONDOKUZ MAYIS UNIVERSITY INTERNATIONAL STUDENT EXAM May 17, 2015

ENGLISH

NAME	:
SURNAME	:
ID NUMBER	:
SIGNATURE	:	SEAT NUMBER:

IMPORTANT INFORMATION

- This booklet includes test questions for international students who wish to study in certain Turkish universities.
The number of questions are as follows:

Mathematics	40
Basic Learning Skills	40
- This is an "A" type booklet. Please mark the type of your booklet on the answer sheet as shown below, and make sure it has been confirmed by the exam supervisor.
If you do not code the booklet type correctly on the answer sheet, your exam will be invalid.
- You have **120 minutes** to complete the exam.
- Each question has only one correct answer. Multiple selections will be considered as incorrect.
- The answers to the questions given in the booklet should be marked by pencil on the answer sheet provided with this booklet. Please use a pencil. Do not fold the answer sheet and do not write anything not required on it.
- Inappropriate markings on the answer sheet will not be read by the optical reader. The candidate is responsible for the mistakes incurred by inappropriate markings.**
- Only correct answers will be calculated in this exam. You will not lose any points for incorrect answers.
- Further information on examination rules are printed on the back cover of this booklet.

TYPE OF THE QUESTION BOOKLET

A ●	B ○
PARAPH	PARAPH

EXAMPLE

MATHEMATICS

$$1. \frac{(-2^2)^{-1} : 2^{-2} - 2^{-2}}{-2^{-1} + (2 - 2^{-2})} = ?$$

A) $-\frac{5}{4}$

B) -1

C) 0

D) 1

E) $\frac{5}{4}$

$$4. \frac{7 : \frac{14}{3} - \frac{7}{2} + \left(\frac{2}{3}\right)^{-2}}{\frac{1}{10} : \frac{6}{5} - 1} = ?$$

A) 3

B) $\frac{1}{4}$

C) $-\frac{3}{11}$

D) $-\frac{9}{4}$

E) 7

$$3. 6 : \frac{\frac{2+x}{2} - 1}{1 - \frac{1}{2}} = 3 \Rightarrow x = ?$$

A) -1

B) $-\frac{1}{2}$

C) $\frac{1}{2}$

D) 2

E) 8

6. If a , b and c are consecutive even integers and $a < b < c$ then

$$\frac{(a-c) \cdot (b-a)^2}{b-c} = ?$$

A) -8

B) -4

C) -2

D) 4

E) 8

8. If $x = 2^{60}$, $y = 3^{84}$, and $\frac{108}{z} = 5^{108}$, which one of the following is correct?

- A) $z < x < y$
 B) $z < y < x$
 C) $y < x < z$
 D) $x < z < y$
 E) $x < y < z$

9. $\frac{2^6 - 2^{12}}{(2^3 + 1)(2^3 - 1)} = ?$

- A) -2^{12} B) -2^6 C) 2^6
 D) 2^8 E) 2^{12}

12. If 10% of 70% is 14, what is the actual number?

- A) 120 B) 150 C) 200
 D) 220 E) 250

13. What is the sum of all real numbers x satisfying the equation $|(x-1)^2| = 4$?

- A) -3 B) -2 C) 1 D) 2 E) 3

14.

Age	5	7	10	12
Number of Children	2	4	3	1

The above table shows the number and ages of a group of children. What is the mean age of this group?

- A) 6 B) 8 C) 10 D) 12 E) 14

$$15. \left. \begin{array}{l} \frac{a}{2} = \frac{b}{3} = \frac{c}{5} \\ 4a - 5b + 3c = 16 \end{array} \right\} \Rightarrow a + b + c = ?$$

- A) -20 B) -10 C) 10 D) 20 E) 30

$$17. \left. \begin{array}{l} x + y = 15 \\ y + z = 16 \\ x + z = 17 \end{array} \right\} \Rightarrow x + y + z = ?$$

- A) 35 B) 33 C) 30 D) 27 E) 24

$$18. \left. \begin{array}{l} A = \{1, \{1\}, 2, 3, \{2, 3\}\} \\ B = \{1, \{2\}, \{1, 2\}, \{3\}, 3\} \end{array} \right\} \Rightarrow A \cap B = ?$$

- A) $\{1, 3\}$ B) $\{3\}$ C) $\{1, 2, 3\}$
D) $\{\{1, 2\}, 3\}$ E) $\{1, \{2\}, \{3\}\}$

$$19. f(x+1) - f(x) = \frac{1}{2}, \quad f(1) = 3 \Rightarrow f(100) = ?$$

- A) $\frac{101}{2}$ B) $\frac{103}{2}$ C) $\frac{105}{2}$
D) $\frac{107}{2}$ E) $\frac{109}{2}$

$$21. Z \in \mathbb{C}, \quad Z = 2 + 3i \Rightarrow I_m(Z^{-1}) = ?$$

- A) $-\frac{3}{13}$ B) $-\frac{2}{13}$ C) 0
D) $\frac{2}{13}$ E) $\frac{3}{13}$

$$22. A = \begin{bmatrix} x-1 & 3 \\ 10 & y+3 \end{bmatrix}, \quad B = \begin{bmatrix} 2 & z \\ 10 & -5 \end{bmatrix},$$

$$A = B \Rightarrow x \cdot y + z = ?$$

- A) -18 B) -19 C) -20
D) -21 E) -22

23. $\log_7(4x-5) - \log_7(3x+4) = 0 \Rightarrow x = ?$

- A) 7 B) 8 C) 9 D) 10 E) 11

24. Which one of the below is the most general

domain of the function $f(x) = \frac{x^2 + 1}{1 - |x - 1|}$?

- A) $\mathbb{R} - \{0, 2\}$ B) $\mathbb{R} - \{2\}$ C) $\mathbb{R} - \{0\}$
D) $\mathbb{R} - \{0, -2\}$ E) \mathbb{R}

26. The function $f(x) = \int (\sin x + 2 \cos x) dx$ is given. If $f\left(\frac{\pi}{2}\right) = 2$, then $f(0) = ?$

- A) -2 B) -1 C) 0 D) 1 E) 2

28. The function

$$f(x) = \begin{cases} ax+1, & x < -1 \\ 2x-a, & -1 \leq x < 2 \\ \frac{a}{3}x+5, & x \geq 2 \end{cases}$$

is given.

If $f(1) = f(-2)$, then $f(3) = ?$

- A) 2 B) 3 C) 4 D) 5 E) 6

32. $f(2x) = \frac{2x}{x^3 + 1}$, $f'(2) = ?$

A) $-\frac{1}{2}$

B) $\frac{1}{4}$

C) $-\frac{1}{4}$

D) $\frac{10}{27}$

E) $-\frac{10}{27}$

30. If the function $f(x) = \begin{cases} 3x+a, & x < -1 \\ 4, & x = -1 \\ 2x^2 - b, & x > -1 \end{cases}$

is continuous in \mathbb{R} , then $a+b = ?$

A) 1

B) 2

C) 3

D) 4

E) 5

33.

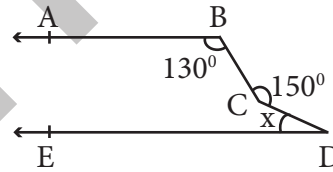

[BA // DE

$m(\widehat{ABC}) = 130^\circ$

$m(\widehat{BCD}) = 150^\circ$

$m(\widehat{CDE}) = x = ?$

A) 40

B) 35

C) 30

D) 25

E) 20

31. $\lim_{x \rightarrow 3^-} \frac{|x-3|}{2x-6} = ?$

A) -2

B) $-\frac{1}{2}$

C) 0

D) $\frac{1}{2}$

E) 2

35.

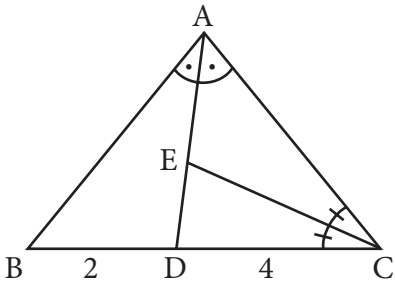

ABC triangle, [AD] and [CE] internal bisector
 $2 \cdot |AE| = 5 \cdot |ED|$
 $|BD| = 2 \text{ cm}, |CD| = 4 \text{ cm}$

What is the perimeter of triangle ABC?

- A) 20 B) 21 C) 22 D) 23 E) 24

EXAMPLE

40.

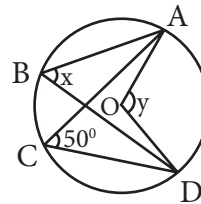

The centre of circle O

$m(\widehat{ACD}) = 50^\circ$

$m(\widehat{AOD}) = y$

$m(\widehat{ABD}) = x$

$x + y = ?$

- A) 120 B) 150 C) 160
 D) 165 E) 180

Mathematics Test is completed.

BASIC LEARNING SKILLS



Which of the below should be replaced in the question mark (?)?

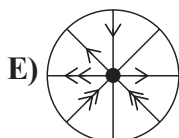
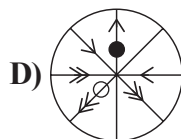
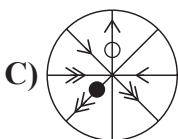
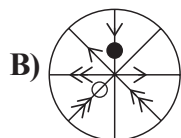
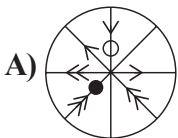

Which number should be replaced in the question mark (?)?

- A) 8 B) 289 C) 216
 D) 512 E) 225



Which number should be replaced in the question mark (?)?

- A) 12.25 B) 12 C) 11,75
 D) 11,5 E) 11,25

7.

5	2	6	3	●
3	6	3	6	●
6	3	6	3	●
2	6	3	7	●

Which of the following is the shaded area in the above table?

- A)

3
5
6
2
- B)

1
2
3
4
- C)

3
5
4
7
- D)

3
6
3
8
- E)

2
7
3
3

8.

17	410	33	39	711	24	57	?	51
----	-----	----	----	-----	----	----	---	----

Which number should be replaced in the question mark (?)?

- A) 612 B) 576 C) 512 D) 126 E) 675

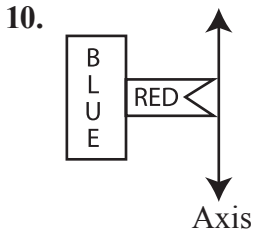

Which of the below is symmetric with respect to the axis of the above figure?

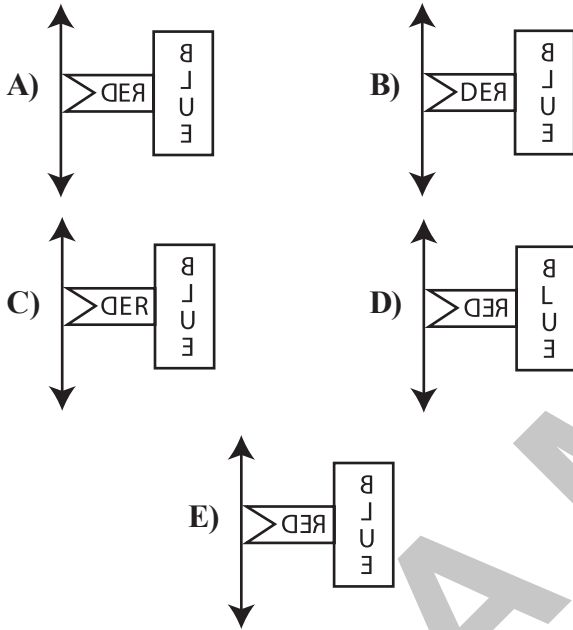

11. If today is Thursday 22.00, what will be the day and time after 225 hours?

- | | <u>Day</u> | <u>Time</u> |
|----|------------|-------------|
| A) | Saturday | 07:00 |
| B) | Friday | 07:00 |
| C) | Saturday | 19:00 |
| D) | Sunday | 07:00 |
| E) | Sunday | 19:00 |

14. If, $21 \quad 18 \quad 24 \quad 15 \quad \triangle \quad 12$
 and $9 \quad 11 \quad 14 \quad 18 \quad \triangle \quad 35 \quad \square$,

then, $\square = ?$

- A) 42 B) 48 C) 50 D) 62 E) 64

17.

○	△	□	
△	□	⬠	
□	⬠	⬡	
⬠	⬡	⬢	

Which of the following is the shaded area in the above table?

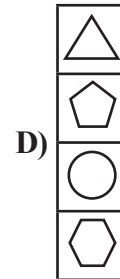
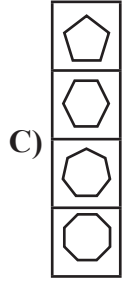
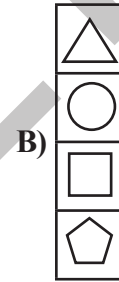

16. What is the mirror reflection of the clock at 20:25?

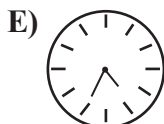
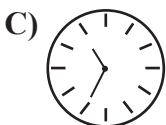
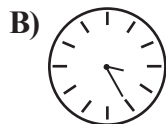
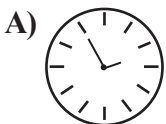

19.

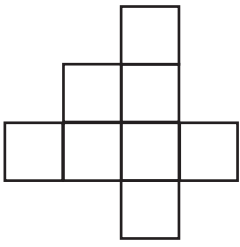

Which of the following is not a part of the above figure?

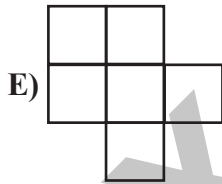
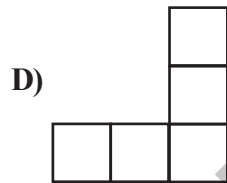
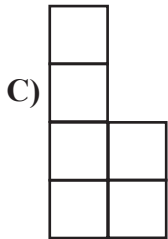
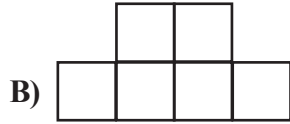
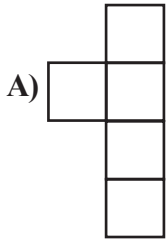

21.

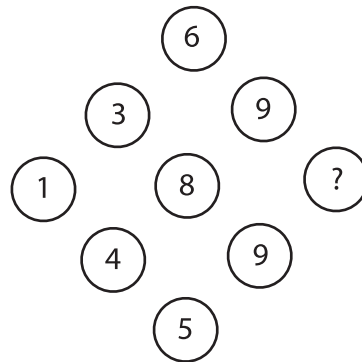

Which number should be replaced in the question mark (?)?

- A) 6 B) 7 C) 8 D) 9 E) 10

22.

15	10	25	20	35	30	45	X	Y
----	----	----	----	----	----	----	---	---

$$X+Y=?$$

- A) 25 B) 55 C) 65 D) 85 E) 95

26.

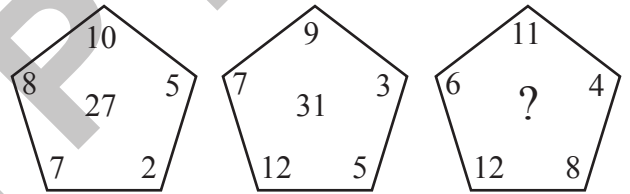

Which number should be replaced in the question mark (?)?

- A) 17 B) 55 C) 41 D) 36 E) 38

24.

$$\triangle 2 = 3 \cdot 2 = 6$$

$$\odot 4 = 2 \cdot \pi \cdot 4 = 8\pi$$

$$\frac{\triangle \pi + \triangle \pi}{\odot 6} = ?$$

- A) $\frac{1}{4}$ B) $\frac{1}{3}$ C) $\frac{1}{2}$ D) $\frac{3}{4}$ E) 1

28.

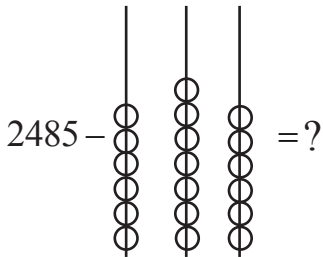
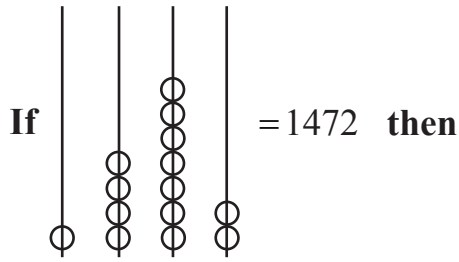

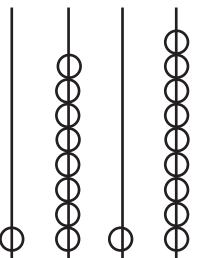
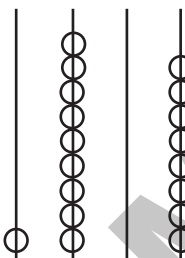
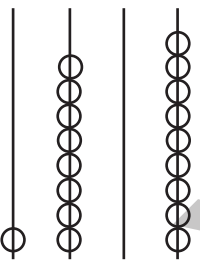
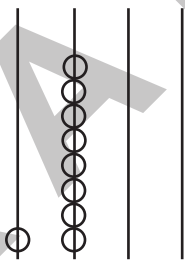
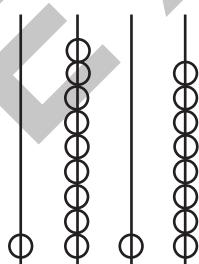
- A) 
- B) 
- C) 
- D) 
- E) 

29.

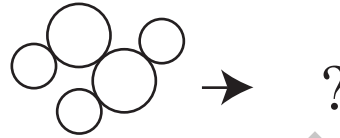
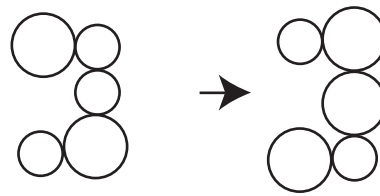

Which of the below should be replaced in the question mark (?)?

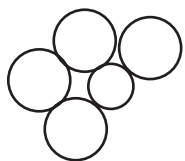
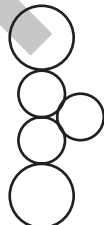
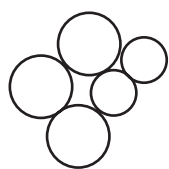
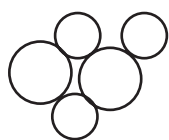
- A) 
- B) 
- C) 
- D) 
- E) 

EXAMPLE

31. $\begin{matrix} \textcircled{1} & \textcircled{2} \\ \textcircled{8} \\ \textcircled{2} & \textcircled{4} \end{matrix}$ $\begin{matrix} \textcircled{3} & \textcircled{4} \\ \textcircled{48} \\ \textcircled{6} & \textcircled{8} \end{matrix}$ $\begin{matrix} \textcircled{5} & \textcircled{6} \\ \textcircled{X} \\ \textcircled{10} & \textcircled{12} \end{matrix}$ $\begin{matrix} \textcircled{7} & \textcircled{8} \\ \textcircled{224} \\ \textcircled{14} & \textcircled{Y} \end{matrix}$

$X+Y=?$

- A) 142 B) 136 C) 130 D) 124 E) 118

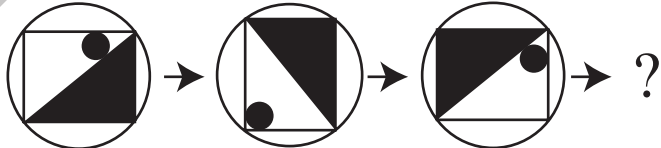
33. 

Which of the below should be replaced in the question mark (?)?

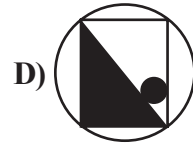
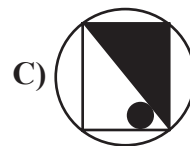
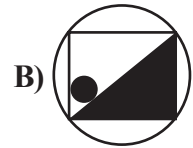
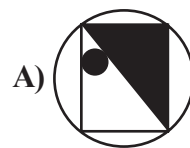

34.

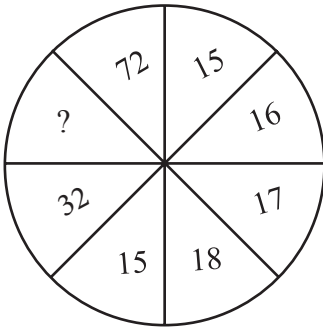

Which number should be replaced in the question mark (?)?

- A) 49 B) 51 C) 59 D) 61 E) 69

35.

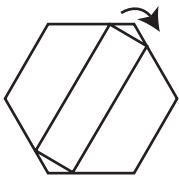

If the above figure turns in the direction of the arrow at an angle of 240° , what is the result?

- A) B)
- C) D)
- E)

36.

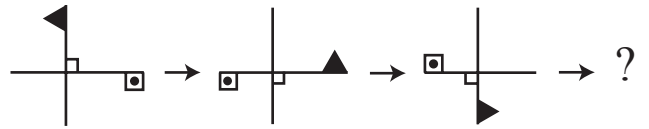

Which of the below should be replaced in the question mark (?)?

- A)
- B)
- C)
- D)
- E)

37.

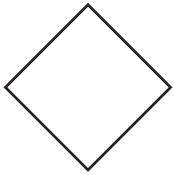

Figure-I

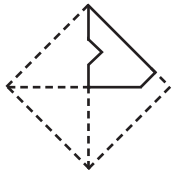
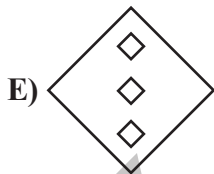
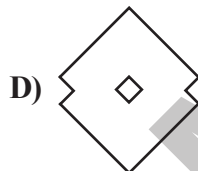
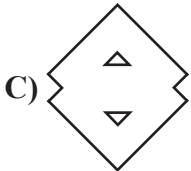
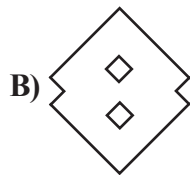

Figure-II

The paper in the figure of rhombus (given in Figure-I) is folded and cut as shown in Figure-II. Then the paper is re-opened.

Which of the following figure will be obtained?



39. If the figures below form a group, which is the odd one out?

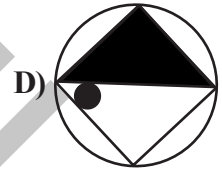
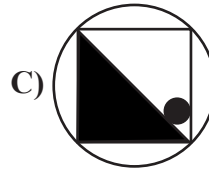
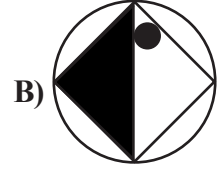
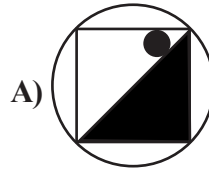

40.



If the above figure is completed with a total of 47 black squares, how many white squares will there be?

- A) 80 B) 79 C) 78 D) 77 E) 76

EXAMPLE



A

EXAMINATION RULES

1. Following materials are prohibited in exam room: Any communication equipments e.g. pagers, walkie-talkies, PDA's, watches with any other functions, weapons, notebooks, books, dictionaries, any electronic device with dictionary function, calculators, calculation charts, compasses, goniometers, rulers and etc. If any candidate enters the exam room with the prohibited materials, his/her name will be recorded and their examinations will be considered invalid.

2. Duration of the exam is **120** minutes. Candidates are not allowed to leave the exam room in the first **30** minutes and the last **5** minutes of the examination. Candidates who completed the exam or left the examination room will not be allowed to re-enter the examination room. If you complete the exam before the end of the duration you can leave the room after submitting your question booklet and answer sheet. When the end of the examination is announced you must remain seated and may not leave the examination room until all papers are collected by the invigilators.

3. Communicating to the invigilators during the examination is prohibited. Similarly, it is prohibited for the staff to talk to candidates privately. Candidates are not allowed for exchange of pencils, erasers, papers etc. during the exam.

4. Exam of any candidate who cheats, attempts to cheat or assists cheating will be considered invalid and his/her identity will be recorded. Invigilators do not have to warn the students about cheating. Candidate is responsible for his/her actions. Answers of the candidates will be examined electronically. If any suspicious case is detected regarding individual or collaborate cheating, exams of all candidates seem to participate in this action will be considered invalid. If invigilators reports any case of misconduct in application of the exam or collaborate cheating, OMÜ-YÖS Coordinating Office may decide to consider all of the candidates' exams invalid for that room.

5. All candidates must obey the rules in the exam room. If necessary your seat may be changed by invigilators. Obeying the rules is of utmost importance for validation of the exam. Identity of any candidate who is engaging in

misconduct and does not heed the invigilator's warning to discontinue the behavior will be recorded and his/her examination will be considered invalid.

6. You must fill all the required fields on the answer sheet. Only pencils should be used for marking and writing on the answer sheet. Pens or ball point pens should not be used. All the answers should be marked on answer sheet. Answers marked on the question booklet will be considered invalid.

7. Please check your question booklet for missing pages or typos after receiving it. If there are any missing pages or typos on your booklet, please immediately request for changing of the booklet from the head invigilator. You should also check if the booklet type written on the cover page is same with the booklet type written on every page of the booklet. If you find any difference please request a new booklet from the head invigilator. If you realise any difference about booklet types after you start the examination, request a new booklet of the same type you have answered. Please mark your booklet type on the "Question Booklet Type" area on the answer sheet. Booklet type you have marked will be checked by the invigilators and initialed with a pen. If the related area is not initialed, your answer sheet will not be evaluated. If there is difference between booklet types that you have marked and invigilator have marked evaluation will be based on the one that is marked by invigilators.

8. Please write your name, surname and candidate number on the question booklet before starting to answer the questions. All the question booklets and answer sheets will be collected and examined at the end of the examination. In case of missing pages, examination of the related candidate will be considered invalid.

9. You can use the spaces on the question booklet for calculation.

10. Smoking (cigarettes, pipes, cigars etc.) is not allowed during the examination for both candidates and the staff.

11. Writing the questions and/or the answers and taking it out is strictly prohibited.

12. Do not forget to submit your question booklet and answer sheet before leaving the exam room.

TO BE HELD IN NIGERIA**ANNOUNCEMENT! ANNOUNCEMENT! ANNOUNCEMENT!**

We are delighted to tell Nigerians OMU YOS is to be held in Nigeria this coming year..



OMÜ-YÖS was first held on May 27, 2012, in 16 countries, and 21 exam centers, in Turkish and English and was attended by 709 candidates. There has been a significant increase in the number of countries and centers where the exam is held and the number of exam languages and attendee students. The exam of 2016 was held in 18 countries, 28 exam centers, and 6 languages (Turkish, English, Russian, Arabic, French, and German) in total. The preliminary works for OMÜ-YÖS 2017 to be conducted in 3 continents and various countries have started.

A.S.M CONSULTANCY IS TO ORGANIZE OMU YOS IN NIGERIA.

ALONG WITH OMU UZEM, YOS IS PLANNED TO BE ORGANIZED IN KANO NIGERIA, NEXT YEAR IN MAY..

The number of universities accepting OMÜ-YÖS (Entrance Examination for International Students) is growing each passing day. OMÜ-YÖS is taken by international students wishing to study at Ondokuz Mayıs University, and the exam's result is accepted by 72 states, 47 private universities, and 119 universities in total. This exam is carried out under the coordinatorship of OMU International Relations Office jointly with OMU Distance Education Center (UZEM). The number of universities accepting OMÜ-YÖS (Entrance Examination for International Students) is growing each passing day. OMÜ-YÖS is taken by international students wishing to study at Ondokuz Mayıs University,



PRIVATE UNIVERSITIES

APPLY TO OMU YOS EXAM TO GET ADMISSION TO MORE THAN 90 UNIVERSITIES IN TURKEY. APPLY TO OMU YOS EXAM TO GET ADMISSION TO MORE THAN 90 UNIVERSITIES IN TURKEY. APPLY TO OMU YOS EXAM TO GET ADMISSION TO MORE THAN 90 UNIVERSITIES IN TURKEY. APPLY TO OMU YOS EXAM TO GET ADMISSION TO MORE THAN 90 UNIVERSITIES IN TURKEY. APPLY TO OMU YOS EXAM TO GET ADMISSION TO MORE THAN 90 UNIVERSITIES IN TURKEY.

A.S.M Consultancy is to organize the YOS exam (JAMB) in Nigeria next year. The exam takes place during May, successful students will be admitted to their university of choice. There are more than 80 public and 50 private universities that accept the OMU YOS exam. We need 100 candidates in order to bring the exam to Nigeria. Apply here to actualize your dream of studying abroad.